

2007

# On a convex Operator for Finite Sets

Branko Ćurgus

Western Washington University, [branko.curgus@wwu.edu](mailto:branko.curgus@wwu.edu)

Krzysztof Kołodziejczyk

Politechnika Wroclawska

Follow this and additional works at: [https://cedar.wwu.edu/math\\_facpubs](https://cedar.wwu.edu/math_facpubs)



Part of the [Mathematics Commons](#)

---

## Recommended Citation

Ćurgus, Branko and Kołodziejczyk, Krzysztof, "On a convex Operator for Finite Sets" (2007). *Mathematics*. 67.  
[https://cedar.wwu.edu/math\\_facpubs/67](https://cedar.wwu.edu/math_facpubs/67)

This Article is brought to you for free and open access by the College of Science and Engineering at Western CEDAR. It has been accepted for inclusion in Mathematics by an authorized administrator of Western CEDAR. For more information, please contact [westerncedar@wwu.edu](mailto:westerncedar@wwu.edu).

# On a convex operator for finite sets

Branko Ćurgus<sup>a</sup>, Krzysztof Kołodziejczyk<sup>b,\*</sup>

<sup>a</sup>*Department of Mathematics, Western Washington University  
Bellingham, Washington 98226, USA*

<sup>b</sup>*Institute of Mathematics and Computer Science  
Wrocław University of Technology  
Wybrzeże Wyspiańskiego 27, 50-370 Wrocław, Poland*

---

## Abstract

Let  $S$  be a finite set with  $m$  elements in a real linear space and let  $\mathcal{J}_S$  be a set of  $m$  intervals in  $\mathbb{R}$ . We introduce a convex operator  $\text{co}(S, \mathcal{J}_S)$  which generalizes the familiar concepts of the convex hull,  $\text{conv } S$ , and the affine hull,  $\text{aff } S$ , of  $S$ . We prove that each homothet of  $\text{conv } S$  that is contained in  $\text{aff } S$  can be obtained using this operator. A variety of convex subsets of  $\text{aff } S$  with interesting combinatorial properties can also be obtained. For example, this operator can assign a regular dodecagon to the 4-element set consisting of the vertices and the orthocenter of an equilateral triangle. For two types of families  $\mathcal{J}_S$  we give two different upper bounds for the number of vertices of the polytopes produced as  $\text{co}(S, \mathcal{J}_S)$ . Our motivation comes from a recent improvement of the well-known Gauss-Lucas theorem. It turns out that a particular convex set  $\text{co}(S, \mathcal{J}_S)$  plays a central role in this improvement.

*Key words:* Convexity; Polytope; Homothety; Minimal family; Irreducible family; Lucas polygon

*1991 MSC:* 52A05, 52B05, 52B11, 52A40

---

---

\* Corresponding author

*Email addresses:* [curgus@cc.wvu.edu](mailto:curgus@cc.wvu.edu), [kolodz@pwr.wroc.pl](mailto:kolodz@pwr.wroc.pl) (Krzysztof Kołodziejczyk).

## 1 Introduction

Let  $S = \{x_1, \dots, x_m\}$  be a finite set of distinct points in a real linear space  $\mathbf{L}$ . The familiar convex sets associated with  $S$  are the convex hull of  $S$

$$\text{conv } S = \left\{ \sum_{j=1}^m \xi_j x_j : x_j \in S, \xi_j \geq 0, \sum_{j=1}^m \xi_j = 1 \right\} \quad (1.1)$$

and the affine hull of  $S$

$$\text{aff } S = \left\{ \sum_{j=1}^m \xi_j x_j : x_j \in S, \xi_j \in \mathbb{R}, \sum_{j=1}^m \xi_j = 1 \right\}.$$

The set in (1.1) will not change if the conditions  $\xi_j \geq 0$  are replaced by the conditions  $\xi_j \in [0, 1]$ ,  $j = 1, \dots, m$ . This leads us to ask the following natural question: How will the set on the right-hand side of (1.1) change when the conditions  $\xi_j \geq 0$  are replaced by the conditions  $\xi_j \in I_j$ ,  $j = 1, \dots, m$ , where  $I_j$  are arbitrary nonempty intervals in  $\mathbb{R}$ ? An immediate and obvious answer is that the resulting set will always be a subset of  $\text{aff } S$ . In this article we explore this question further. That is, we study the subsets of  $\mathbf{L}$  introduced by the following definition.

**Definition 1.1** Let  $S = \{x_1, \dots, x_m\}$  be a finite set of distinct points in a linear space  $\mathbf{L}$ . Let  $\mathcal{J}_S = \{I_1, \dots, I_m\}$  be a family of nonempty intervals in  $\mathbb{R}$  (some of which can be degenerated to a singleton) such that the interval  $I_j$  is associated with the point  $x_j$  for each  $j \in \{1, \dots, m\}$ . Set

$$\text{co}(S, \mathcal{J}_S) := \left\{ \sum_{j=1}^m \xi_j x_j : x_j \in S, \xi_j \in I_j, \sum_{j=1}^m \xi_j = 1 \right\}.$$

This set we call a *convex interval hull* of  $S$ .

It is clear that the convex interval hull  $\text{co}(S, \mathcal{J}_S)$  coincides with  $\text{conv } S$  when all the intervals in  $\mathcal{J}_S$  are equal to  $[0, 1]$  and  $\text{co}(S, \mathcal{J}_S)$  coincides with  $\text{aff } S$  when all the intervals in  $\mathcal{J}_S$  are equal to  $\mathbb{R}$ . In this sense  $\text{co}(S, \mathcal{J}_S)$  generalizes these two well-known concepts.

Our primary interest in this article is to explore the family of all convex interval hulls  $\text{co}(S, \mathcal{J}_S)$  which are bounded. Examples in Section 2 show that a variety of convex sets appear in such families even if  $S$  is fixed. It is quite striking that when  $S$  is the set of only 4 points: the vertices and the orthocenter of an equilateral triangle, for example

$$S = \left\{ (-1, 0), (0, 1), (0, \sqrt{3}), (0, 1/\sqrt{3}) \right\},$$

and when

$$\mathcal{J}_S = \{[0, 1], [0, 1], [0, 1], [1 - \sqrt{3}, -2 + \sqrt{3}]\},$$

then  $\text{co}(S, \mathcal{J}_S)$  is a regular dodecagon; see Figure 12.

An inverse problem in this setting is as follows: For a given convex set  $K$  find a finite set  $S$  with minimal cardinality and a family  $\mathcal{J}_S$  of intervals such that  $K = \text{co}(S, \mathcal{J}_S)$ . Examples 2.7 and 2.10 suggest solutions of the inverse problem for  $K$  equal to a regular dodecagon and for  $K$  equal to a rhombic dodecahedron. This inverse problem and unbounded convex interval hulls will be considered elsewhere.

Let  $m$  be a positive integer. For a fixed family  $\mathcal{J}$  of  $m$  nonempty intervals in  $\mathbb{R}$  our operator  $S \mapsto \text{co}(S, \mathcal{J})$  is a set-valued function defined on finite subsets of  $\mathbf{L}$  with  $m$  elements. Recall that many set-valued functions  $f$  considered in convexity theory are described in the following way:

$$f(X) = \bigcap \{F \in \mathcal{F} : X \subset F\}, \quad X \subset \mathbf{L}, \quad (1.2)$$

where  $\mathcal{F}$  is a prescribed family of subsets of  $\mathbf{L}$ . The convex hull itself and many well-known generalizations of it are obtained in this way, see for example [2] and [6]. An immediate consequence of definition (1.2) is the inclusion  $X \subseteq f(X)$ . From examples in Section 2 and our results in Section 6 it is clear that the convex interval hull does not always satisfy the inclusion  $S \subseteq \text{co}(S, \mathcal{J}_S)$ . As a matter of fact, for every set  $S$  there are families of intervals  $\mathcal{J}_S$  for which  $S$  is not a subset of  $\text{co}(S, \mathcal{J}_S)$ . In this sense our operator differs from operators described by (1.2).

Definitions similar to Definition 1.1 appeared in [4] and [5]. We recall the following three definitions from [5, p. 363]. First, for nonempty sets  $\Lambda \subset \mathbb{R}^m$  and  $S \subset \mathbf{L}$  denote by  $\Lambda \cdot S \subset \mathbf{L}$  the set of all  $\sum_{j=1}^m \lambda_j s_j$ , where  $(\lambda_1, \dots, \lambda_m) \in \Lambda$  and  $s_j \in S$ ,  $j = 1 \dots, m$ . Second, a set  $S \subset \mathbf{L}$  is called *endo- $\Lambda$*  if  $\Lambda \cdot S \subseteq S$ . Third, with  $\mathcal{F}$  being the family of all endo- $\Lambda$  sets, (1.2) defines the  $\Lambda$ -hull operator. A special case of  $\Lambda$ -hull operator with  $\Lambda = \{(\xi, 1 - \xi) : \xi \in \Delta\} \subset \mathbb{R}^2$ , where  $\Delta$  is any non-empty subset of  $[0, 1]$  containing at least one point interior to  $[0, 1]$ , was considered in [4]. In [4] endo- $\Lambda$  sets are called  $\Delta$ -convex sets. (We notice that Motzkin in [5] does not refer to [4].)

In this paragraph we point out the differences between the definitions of  $\Lambda \cdot S$  and  $\text{co}(S, \mathcal{J}_S)$ . To this end, let  $\Lambda$  be the intersection of  $I_1 \times \dots \times I_m$  and the hyperplane  $\sum_{j=1}^m \xi_j = 1$ , where  $I_j$  are nonempty intervals in  $\mathbb{R}$ , and let  $S = \{x_1, \dots, x_m\}$ , where  $x_1, \dots, x_m$  are distinct points in  $\mathbf{L}$ . Then, in general,  $\Lambda \cdot S$  contains more linear combinations than  $\text{co}(S, \mathcal{J}_S)$ . The first reason for this is that, with  $(\xi_1, \dots, \xi_m) \in \Lambda$ ,  $\sum_{j=1}^m \xi_j s_j \in \Lambda \cdot S$  whenever  $s_1, \dots, s_m \in S$ , while for  $\sum_{j=1}^m \xi_j x_j \in \text{co}(S, \mathcal{J}_S)$  it is essential that  $x_1, \dots, x_m$  are distinct points in

$S$ . For example, with  $s_1 = \dots = s_m = s \in S$ , the condition  $\sum_{j=1}^m \xi_j = 1$  implies  $S \subset \Lambda \cdot S$ , while  $S \subset \text{co}(S, \mathcal{J}_S)$  is not true in general. The second reason is that in the definition of  $\text{co}(S, \mathcal{J}_S)$  the point  $x_j \in S$ , for fixed  $j \in \{1, \dots, m\}$ , is scaled *only* by scalars in  $I_j$ , while there is no such restriction in the definition of  $\Lambda \cdot S$ . We also remark that the geometry of the sets  $\Lambda \cdot S$  and the properties of the operator  $S \mapsto \Lambda \cdot S$  for a fixed  $\Lambda$  were not considered in [4] and [5].

The following geometric way of looking at  $\text{co}(S, \mathcal{J}_S)$  will be very useful in the investigation of combinatorial properties of  $\text{co}(S, \mathcal{J}_S)$ . Notice that the restrictions imposed on  $\xi = (\xi_1, \dots, \xi_m)$  in Definition 1.1 mean that  $\xi$  belongs to the intersection  $D$  of the brick  $I_1 \times \dots \times I_m \subset \mathbb{R}^m$  and the hyperplane  $\Pi_1$  defined by  $\sum_{j=1}^m \xi_j = 1$ . Thus  $\text{co}(S, \mathcal{J}_S)$  is an image of  $D$  under a linear mapping  $T_S : \mathbb{R}^m \rightarrow \mathbf{L}$  defined by

$$T_S(\xi_1, \xi_2, \dots, \xi_m) := \sum_{j=1}^m \xi_j x_j. \quad (1.3)$$

The article is organized as follows. In Section 2 we give several illustrative examples of convex interval hulls in  $\mathbb{R}^2$  and  $\mathbb{R}^3$  for sets  $S$  with three, four and five points. In Section 3 we characterize nonemptiness and boundedness of  $\text{co}(S, \mathcal{J}_S)$ . In Section 4 we prove that all bounded convex interval hulls are polytopes. Here we provide two upper bounds for the number of vertices of such polytopes. The first bound is general and the second one deals with polytopes obtained as  $\text{co}(S, \mathcal{J}_S)$  for a special class of families  $\mathcal{J}_S$ . As we have already noticed, different families of intervals can result in the same convex interval hulls. In Section 5 we study minimality conditions for a family of intervals, where minimality is understood in such a way that any further shrinking of intervals results in a smaller convex interval hull. In Section 6 we prove that a family of bounded convex interval hulls of a fixed finite set  $S$  is invariant under homotheties. As a special case of this result we obtain that for each homothet  $K$  of  $\text{conv } S$  there exists a family of intervals  $\mathcal{J}_S$  such that  $K = \text{co}(S, \mathcal{J}_S)$ . We use this result to give a detailed description of bounded convex interval hulls of finite affinely independent subsets of a linear space.

In this paragraph we introduce the notation. By  $\mathbb{R}$  we denote the real numbers. The symbol  $\mathbf{L}$  denotes a real linear space and  $\|\cdot\|$  is a norm in this space. A specific linear space that we will encounter is  $\mathbb{R}^m$ , where  $m$  is a positive integer. The linear operations from  $\mathbf{L}$  are extended to subsets of  $\mathbf{L}$  in the following standard way. For subsets  $K$  and  $M$  of  $\mathbf{L}$  and  $\alpha, \beta \in \mathbb{R}$  we put

$$\alpha K + \beta M = \{\alpha x + \beta y : x \in K, y \in M\}.$$

For a mapping  $T : \mathbf{L} \rightarrow \mathbf{L}$ ,  $T(K)$  denotes the set of all  $Tx$ ,  $x \in K$ .

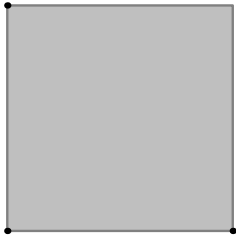

Fig. 1. Square

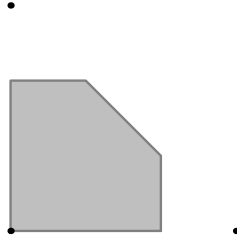

Fig. 2. Pentagon

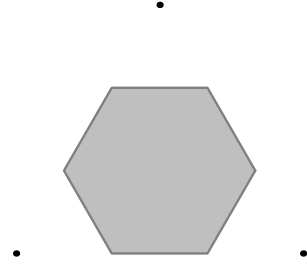

Fig. 3. Regular hexagon

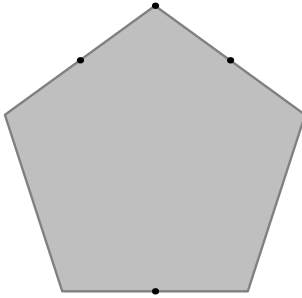

Fig. 4. Regular pentagon

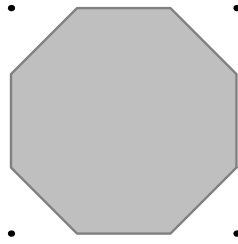

Fig. 5. Regular octagon

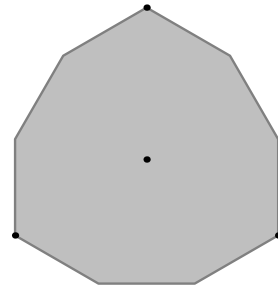

Fig. 6. Nonagon

## 2 Examples

In this section we present several examples of convex interval hulls. All examples here are bounded sets, since our main interest in this article are convex interval hulls which are bounded sets. We will consider unbounded convex interval hulls elsewhere. For completeness we start with the standard example.

**Example 2.1** Let  $S = \{x_1, \dots, x_m\}$  be a finite set of points in a linear space  $\mathbf{L}$  and let  $\mathcal{J}_S = \{I_1, \dots, I_m\}$  with  $I_j = [0, t_j]$ , where  $t_j \geq 1$ ,  $j = 1, \dots, m$ . Then

$$\text{co}(S, \mathcal{J}_S) = \text{conv } S.$$

All examples are calculated and plotted using *Mathematica*. In each example the points of the set  $S$  are listed starting from the lowest point that is furthest to the left. Then we proceed counterclockwise, finishing with the point inside. In each figure the points in  $S$  are marked with black dots ( $\bullet$ ) and the polygon  $\text{co}(S, \mathcal{J}_S)$  is shaded gray with its edges slightly darker.

**Example 2.2** In Figures 1 and 2, we use  $S = \{(0, 0), (1, 0), (0, 1)\}$ . In Fig. 1 we use  $\mathcal{J}_S = \{[-1, 1], [0, 1], [0, 1]\}$  to get a square and in Fig. 2 we use  $\mathcal{J}_S = \{[0, 1], [0, 2/3], [0, 2/3]\}$  to get an irregular pentagon.

**Example 2.3** In Fig. 3 we use

$$S = \{(-1, 0), (0, 1), (0, \sqrt{3})\} \quad \text{and} \quad \mathcal{J}_S = \{[0, 2/3], [0, 2/3], [0, 2/3]\},$$

to get a regular hexagon.

**Example 2.4** In Fig. 4 we use

$$S = \left\{ \left( 0, -5 - 2\sqrt{5} \right), \left( \sqrt{10 + 2\sqrt{5}}, \sqrt{5} \right), (0, 5), \left( -\sqrt{10 + 2\sqrt{5}}, \sqrt{5} \right) \right\},$$

$$\mathcal{J}_S = \{[0, 3 - \sqrt{5}], [0, 2], [-1, 1], [0, 2]\},$$

to get a regular pentagon.

**Example 2.5** In Fig. 5 we use  $S = \{(0, 0), (1, 0), (1, 1), (0, 1)\}$  and  $\mathcal{J}_S$  that consists of four copies of the interval  $[0, \sqrt{2}/2]$  to get a regular octagon.

**Example 2.6** In Fig. 6 we use

$$S = \{(-1, 0), (0, 1), (0, \sqrt{3}), (0, 1/\sqrt{3})\},$$

$$\mathcal{J}_S = \{[0, 1], [0, 1], [0, 1], [(\sqrt{3} - 3)/2, 1]\},$$

to get an irregular nonagon with all equal sides.

**Example 2.7** In Figures 7 through 12 we show six different convex interval hulls corresponding to the same set  $S$  that is used in Example 2.6. We start with an equilateral triangle in Fig. 7 and proceed by changing one interval at each step to finish with a regular dodecagon in Fig. 12. We use the following families of intervals:

Fig. 7	$\mathcal{J}_S = \{[0, 2], [0, 2], [0, 2], [-1, 0]\},$
Fig. 8	$\mathcal{J}_S = \{[0, 1], [0, 2], [0, 2], [-1, 0]\},$
Fig. 9	$\mathcal{J}_S = \{[0, 1], [0, 1], [0, 2], [-1, 0]\},$
Fig. 10	$\mathcal{J}_S = \{[0, 1], [0, 1], [0, 1], [-1, 0]\},$
Fig. 11	$\mathcal{J}_S = \{[0, 1], [0, 1], [0, 1], [1 - \sqrt{3}, 0]\},$
Fig. 12	$\mathcal{J}_S = \{[0, 1], [0, 1], [0, 1], [1 - \sqrt{3}, -2 + \sqrt{3}]\}.$

**Example 2.8** In Fig. 13 we use

$$S = \left\{ (-1, 0, 0), (1, 0, 0), (0, \sqrt{3}, 0), (0, 1/\sqrt{3}, 2\sqrt{2/3}) \right\}$$

and  $\mathcal{J}_S$  that consists of four copies of  $[0, 2/3]$  to get a truncated tetrahedron. Notice that the points of  $S$  are vertices of a tetrahedron.

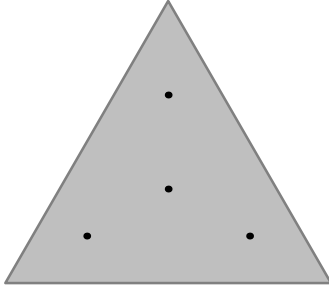

Fig. 7. Step 1

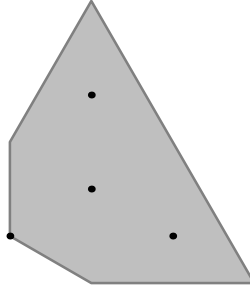

Fig. 8. Step 2

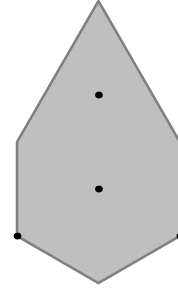

Fig. 9. Step 3

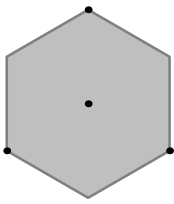

Fig. 10. Step 4

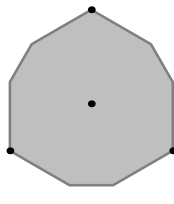

Fig. 11. Step 5

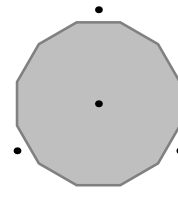

Fig. 12. Regular dodecagon

**Example 2.9** In Fig. 14 we use

$$S = \left\{ (0, 0, 0), (1, 0, 0), (0, 1, 0), (0, 0, 1) \right\}$$

$$\mathcal{J}_S = \left\{ [-2, 1], [0, 1], [0, 1], [0, 1] \right\}$$

to get a cube.

**Example 2.10** In Fig. 15 we use

$$S = \left\{ (-1, 0, 0), (1, 0, 0), (0, \sqrt{3}, 0), \left( 0, \frac{1}{\sqrt{3}}, 2\sqrt{\frac{2}{3}} \right), \left( 0, \frac{1}{\sqrt{3}}, \frac{1}{\sqrt{6}} \right) \right\}$$

$$\mathcal{J}_S = \left\{ [0, 1], [0, 1], [0, 1], [0, 1], [-2, 0] \right\}$$

to get a rhombic dodecahedron. The first four points of  $S$  are vertices of a tetrahedron and the fifth point is its orthocenter.

**Example 2.11** In Fig. 16 we use the same  $S$  as in Example 2.10 and

$$\mathcal{J}_S = \left\{ [0, 1], [0, 1], [0, 1], [0, 1], [-1/2, 0] \right\}.$$



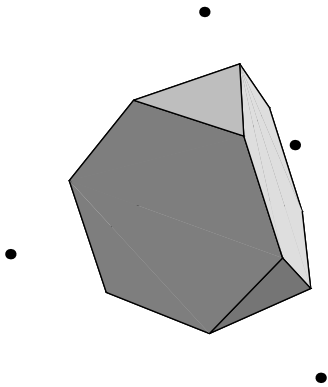

Fig. 13. Truncated tetrahedron

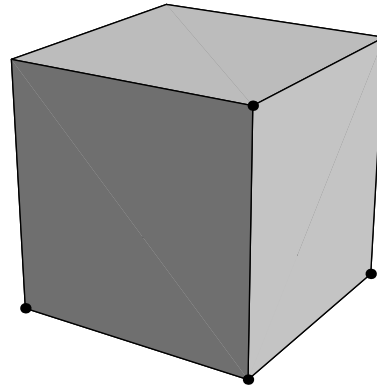

Fig. 14. Cube

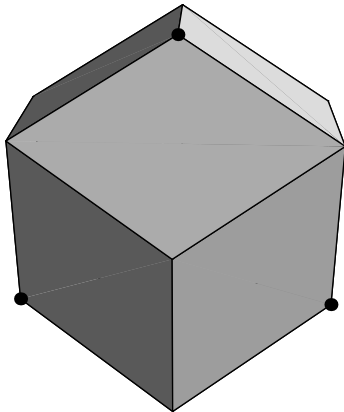

Fig. 15. Rhombic dodecahedron

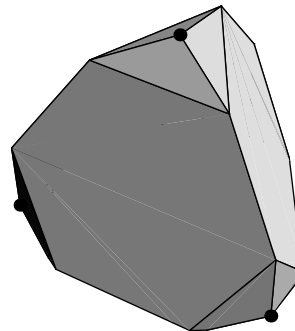

Fig. 16. Example 2.11

### 3 Basic properties of convex interval hulls

In this section most proofs are omitted since they are, though sometimes lengthy, straightforward consequences of the definitions. The proofs that are included indicate how to construct the omitted proofs.

**Proposition 3.1** *Let  $S = \{x_1, \dots, x_m\}$  be a finite set of points in a linear space  $\mathbf{L}$  and let  $\mathcal{J}_S = \{I_1, \dots, I_m\}$ ,  $I_j \subseteq \mathbb{R}$ ,  $j = 1, \dots, m$ , be a family of nonempty intervals. Then the set  $\text{co}(S, \mathcal{J}_S)$  is convex.*

**Proposition 3.2** *Let  $S = \{x_1, \dots, x_m\}$  be a finite set of points in a linear*

space  $\mathbf{L}$  and let  $\mathcal{J}_S = \{I_1, \dots, I_m\}$ ,  $I_j \subseteq \mathbb{R}$ ,  $j = 1, \dots, m$ , be a family of nonempty intervals. If  $\mathcal{J}'_S = \{I'_1, \dots, I'_m\}$  is a family of nonempty intervals such that  $I'_j \subseteq I_j$ ,  $j = 1, \dots, m$ , then  $\text{co}(S, \mathcal{J}'_S) \subseteq \text{co}(S, \mathcal{J}_S)$ .

**Proposition 3.3** *Let  $S = \{x_1, \dots, x_m\}$  be a finite set of points in a linear space  $\mathbf{L}$  and let  $\mathcal{J}_S = \{I_1, \dots, I_m\}$ ,  $I_j \subseteq \mathbb{R}$ ,  $j = 1, \dots, m$ , be a family of nonempty intervals. Put  $a_j = \inf I_j$  and  $b_j = \sup I_j$ ,  $j = 1, \dots, m$ , allowing for the infinite values. Let  $\alpha = \sum_{j=1}^m a_j$  and  $\beta = \sum_{j=1}^m b_j$ . Then  $\text{co}(S, \mathcal{J}_S) \neq \emptyset$  if and only if the following three conditions are satisfied:*

- (a)  $\alpha \leq 1 \leq \beta$ ;
- (b) if  $\alpha = 1$ , then  $a_j \in I_j$ ,  $j = 1, \dots, m$ ; and
- (c) if  $\beta = 1$ , then  $b_j \in I_j$ ,  $j = 1, \dots, m$ .

**Proof.** Assume  $\text{co}(S, \mathcal{J}_S) \neq \emptyset$ . Then there exist  $\xi_j \in I_j$ ,  $j = 1, \dots, m$ , such that  $\sum_{j=1}^m \xi_j = 1$ . Since  $a_j \leq \xi_j \leq b_j$ ,  $j = 1, \dots, m$ , it follows that  $\alpha \leq 1 \leq \beta$ . This proves (a). If  $\alpha = 1$ , then  $a_j = \xi_j$ , and thus  $a_j \in I_j$ ,  $j = 1, \dots, m$ . This proves (b) and (c) is proved similarly.

To prove the converse assume that (a), (b) and (c) hold. If  $\alpha = \beta = 1$ , then each of the intervals is in fact a point and  $\text{co}(S, \mathcal{J}_S)$  consists of a single point. Now assume  $\alpha < \beta$ . It follows from Proposition 3.2 that without loss of generality we can in addition assume that  $\alpha$  and  $\beta$  are finite. Set

$$\xi_j = \frac{\beta - 1}{\beta - \alpha} a_j + \frac{1 - \alpha}{\beta - \alpha} b_j, \quad j = 1, \dots, m.$$

It easily follows that  $\xi_j \in I_j$ ,  $j = 1, \dots, m$ , and  $\sum_{j=1}^m \xi_j = 1$ . Therefore  $x = \sum_{j=1}^m \xi_j x_j \in \text{co}(S, \mathcal{J}_S)$ . Thus  $\text{co}(S, \mathcal{J}_S) \neq \emptyset$  and the proposition is proved.  $\square$

**Theorem 3.4** *Let  $S = \{x_1, \dots, x_m\}$  be a finite set of distinct points in a linear space  $\mathbf{L}$  and let  $\mathcal{J}_S = \{I_1, \dots, I_m\}$ ,  $I_j \subseteq \mathbb{R}$ ,  $j = 1, \dots, m$ , be a family of nonempty intervals. The set  $\text{co}(S, \mathcal{J}_S)$  is bounded if and only if at least one of the conditions below is satisfied.*

- (i) All the intervals in  $\mathcal{J}_S$  are bounded below.
- (ii) All the intervals in  $\mathcal{J}_S$  are bounded above.
- (iii) At most one interval in  $\mathcal{J}_S$  is unbounded.

*If any of the conditions (i)-(iii) is satisfied, then there exists a family of bounded intervals  $\mathcal{J}'_S$  such that  $\text{co}(S, \mathcal{J}_S) = \text{co}(S, \mathcal{J}'_S)$ .*

**Proof.** If all the intervals in  $\mathcal{J}_S = \{I_1, \dots, I_m\}$  are bounded, then  $\text{co}(S, \mathcal{J}_S)$  is clearly bounded.

Assume (i). Let  $a \in \mathbb{R}$  be such that  $I_j \subseteq (a, +\infty)$  for all  $j = 1, \dots, m$ . Since the empty set is bounded, we assume  $\text{co}(S, \mathcal{J}_S) \neq \emptyset$ . By Proposition 3.3, we have  $ma < 1$ . Let  $x \in \text{co}(S, \mathcal{J}_S)$ . Then  $x = \sum_{j=1}^m \xi_j x_j$  for some  $\xi_j \in I_j$ ,  $j = 1, \dots, m$ , such that  $\sum_{j=1}^m \xi_j = 1$ . For arbitrary  $k \in \{1, \dots, m\}$  we have

$$\xi_k = 1 - \sum_{j \neq k}^m \xi_j < 1 - (m-1)a = a + 1 - ma.$$

Therefore  $a < \xi_k < a + 1 - ma$ . From this it follows that  $\text{co}(S, \mathcal{J}_S) \subseteq \text{co}(S, \mathcal{J}'_S)$ , where  $\mathcal{J}'_S$  is the family of intervals  $I'_k = [a_k, b'_k]$  with  $b'_k = \min\{a + 1 - ma, b_k\}$ . By Proposition 3.2 the converse inclusion is also true. Consequently  $\text{co}(S, \mathcal{J}_S) = \text{co}(S, \mathcal{J}'_S)$ . Since each interval in  $\mathcal{J}'_S$  is bounded, the set  $\text{co}(S, \mathcal{J}'_S)$  is bounded. Thus  $\text{co}(S, \mathcal{J}_S)$  is bounded, as well.

Similarly, (ii) implies that  $\text{co}(S, \mathcal{J}_S)$  is bounded.

Assume (iii). We can also assume that (i) and (ii) are not true. Then exactly one of the intervals in  $\mathcal{J}_S$  is unbounded and it equals  $\mathbb{R}$ . Assume that  $I_1 = \mathbb{R}$  and  $I_j = [a_j, b_j]$ ,  $a_j \leq b_j$ ,  $a_j, b_j \in \mathbb{R}$ ,  $j = 2, \dots, m$ . Put  $\alpha = \sum_{j=2}^m a_j$  and  $\beta = \sum_{j=2}^m b_j$ . Clearly  $\alpha \leq \beta$ . Let  $v \in \text{co}(S, \mathcal{J}_S)$  be such that

$$v = \sum_{j=1}^m \xi_j x_j, \quad \sum_{j=1}^m \xi_j = 1, \quad \xi_j \in I_j, \quad j = 1, \dots, m.$$

Then

$$1 - \beta \leq \xi_1 = 1 - \xi_2 - \dots - \xi_m \leq 1 - \alpha.$$

Consequently  $v \in \text{co}(S, \mathcal{J}'_S)$ , where  $\mathcal{J}'_S = \{[1 - \beta, 1 - \alpha], I_2, \dots, I_m\}$ . Therefore  $\text{co}(S, \mathcal{J}_S) \subseteq \text{co}(S, \mathcal{J}'_S)$ . The converse inclusion holds by Proposition 3.2. Therefore  $\text{co}(S, \mathcal{J}_S) = \text{co}(S, \mathcal{J}'_S)$ . Since each interval in  $\mathcal{J}'_S$  is bounded, the set  $\text{co}(S, \mathcal{J}'_S)$  is bounded and so is  $\text{co}(S, \mathcal{J}_S)$ . This completes the proof of "if" part of the theorem.

Next we prove the contrapositive of the "only if" part of the theorem. Assume that (i), (ii) and (iii) are all false. This is equivalent to the fact that the family  $\mathcal{J}_S$  contains at least two unbounded intervals, say  $I_1$  and  $I_2$ , such that  $I_1$  is not bounded from below and  $I_2$  is not bounded from above. Let  $v \in \text{co}(S, \mathcal{J}_S)$  be such that

$$v = \sum_{j=1}^m c_j x_j, \quad \sum_{j=1}^m c_j = 1, \quad c_j \in I_j, \quad j = 1, \dots, m.$$

Then

$$(-\infty, c_1] \subseteq I_1 \quad \text{and} \quad [c_2, +\infty) \subseteq I_2.$$

Consequently, for all  $t \geq 0$ ,

$$(c_1 - t)x_1 + (c_2 + t)x_2 + c_3x_3 + \dots + c_mx_m = v + t(x_2 - x_1) \in \text{co}(S, \mathcal{J}_S).$$

Clearly

$$\|v + t(x_2 - x_1)\| \geq t\|x_2 - x_1\| - \|v\|, \quad t \geq 0.$$

Since by assumption  $x_1 \neq x_2$ , the last inequality implies that  $\text{co}(S, \mathcal{J}_S)$  is unbounded. The theorem is proved.  $\square$

**Proposition 3.5** *Let  $T : \mathbf{L} \rightarrow \mathbf{K}$  be an affine transformation between linear spaces  $\mathbf{L}$  and  $\mathbf{K}$ . Let  $S = \{x_1, \dots, x_m\}$  be a finite subset of  $\mathbf{L}$  and let  $\mathcal{J}_S = \{I_1, \dots, I_m\}$  be a corresponding set of intervals for which  $\text{co}(S, \mathcal{J}_S)$  is bounded. Let  $Q = T(S) = \{y_1, \dots, y_k\}$  be the set with  $k$  elements, where  $k \leq m$ . Set*

$$\mathcal{J}_Q = \{I'_1, \dots, I'_k\} \quad \text{where} \quad I'_j := \sum \{I_i : Tx_i = y_j\}.$$

*Then  $\text{co}(Q, \mathcal{J}_Q) = T(\text{co}(S, \mathcal{J}_S))$ . Each vertex of  $T(\text{co}(S, \mathcal{J}_S))$  is an image of a vertex of  $\text{co}(S, \mathcal{J}_S)$ .*

#### 4 Convex interval hulls and polytopes

Example 2.7 shows that a convex interval hull of four points can have twelve vertices. In the next theorem we give an upper bound for the number of vertices of a convex interval hull for a finite set with  $m$  points. For a real number  $t$ ,  $\lfloor t \rfloor$  denotes the greatest integer that does not exceed  $t$ .

**Theorem 4.1** *Let  $S = \{x_1, \dots, x_m\}$  be a subset of  $\mathbf{L}$  and let  $\mathcal{J}_S$  be a family of closed intervals such that  $\text{co}(S, \mathcal{J}_S)$  is bounded. Then  $\text{co}(S, \mathcal{J}_S)$  is the convex hull of at most*

$$n \binom{m}{n} \quad \text{points, where} \quad n = \left\lfloor \frac{m}{2} \right\rfloor + 1$$

*and this bound is best possible.*

**Proof.** It follows from Proposition 3.3 that there is no loss of generality if we assume that all the intervals in  $\mathcal{J}_S$  are bounded. Set  $I_j = [a_j, b_j]$ ,  $a_j < b_j$ ,  $j = 1, \dots, m$ . Denote by  $B$  the brick  $I_1 \times \dots \times I_m$  and put  $D = B \cap \Pi_1 \subset \mathbb{R}^m$ . Then  $\text{co}(S, \mathcal{J}_S)$  is the image of  $D$  under the linear mapping  $T_S$  defined in (1.3).

If  $v$  is a vertex of  $D$ , then  $v$  must be on an edge of  $B$ . On the other hand, if  $e$  is an edge of  $B$  intersecting  $\Pi_1$  but not lying on  $\Pi_1$ , then there can be only one vertex of  $D$  on  $e$ . Thus, as a simple consequence of [1, Theorem 5] we have that  $\Pi_1$  can intersect at most  $n \binom{m}{n}$  edges of  $B$ . From the two observations we infer that  $D$  has at most  $n \binom{m}{n}$  vertices. By Proposition 3.5,  $\text{co}(S, \mathcal{J}_S) = T_S(D)$  has

fewer vertices than  $D$ . Since  $D$  has at most  $n\binom{m}{n}$  vertices we conclude that  $\text{co}(S, \mathcal{J}_S)$  has at most  $n\binom{m}{n}$  vertices.

To show that the bound is best possible we provide an example in which  $\text{co}(S, \mathcal{J}_S)$  has exactly  $n\binom{m}{n}$  vertices. To this end denote by  $e_1, \dots, e_m$  the standard unit vectors in  $\mathbb{R}^m$  and take  $S = \{x_1, \dots, x_m\}$  and  $\mathcal{J}_S = \{I_1, \dots, I_m\}$ , where

$$x_j = \frac{2m - 2n + 1}{2} e_j, \quad \text{and} \quad I_j = \left[0, \frac{2}{2m - 2n + 1}\right], \quad j = 1, \dots, m.$$

Clearly

$$\text{co}(S, \mathcal{J}_S) = \left\{ \sum_{j=1}^m \beta_j x_j : \beta_j \in I_j, \sum_{j=1}^m \beta_j = 1 \right\}.$$

This, after a straightforward substitution  $\beta_j \frac{2m - 2n + 1}{2} = \zeta_j$ , gives

$$\begin{aligned} \text{co}(S, \mathcal{J}_S) &= \left\{ \sum_{j=1}^m \zeta_j e_j : 0 \leq \zeta_j \leq 1, \sum_{j=1}^m \zeta_j = m - n + 1/2 \right\} \\ &= \left\{ (\zeta_1, \dots, \zeta_m) \in C : \sum_{j=1}^m \zeta_j = m - n + 1/2 \right\}, \end{aligned}$$

where  $C$  is the unit hypercube in  $\mathbb{R}^m$ . From the above it is immediately seen that  $\text{co}(S, \mathcal{J}_S)$  is the intersection of  $C$  and the hyperplane

$$H = \left\{ (\zeta_1, \dots, \zeta_m) \in \mathbb{R}^m : \zeta_1 + \dots + \zeta_m = m - n + \frac{1}{2} \right\}.$$

One can immediately check that  $H$  intersects exactly  $n\binom{m}{n}$  edges of  $C$  at the points whose  $m - n$  coordinates are equal to 1,  $n - 1$  coordinates are equal to 0 and exactly one coordinate is equal to  $1/2$ . Therefore  $\text{co}(S, \mathcal{J}_S)$ , being the intersection of  $H$  and  $C$ , has exactly  $n\binom{m}{n}$  vertices. The proof of the theorem is complete.  $\square$

**Remark 4.2** In the proof of [1, Theorem 5] the hyperplane

$$\Pi_n = \{(\zeta_1, \dots, \zeta_m) \in \mathbb{R}^m : \zeta_1 + \dots + \zeta_m = n\}$$

is mentioned as one which makes the bound  $n\binom{m}{n}$  best possible. In fact, this hyperplane contains  $\binom{m}{n}$  vertices of  $C$ . Since each vertex belongs to exactly  $n$  edges it could be argued that the hyperplane  $\Pi_n$  intersects  $n\binom{m}{n}$  edges of  $C$ . Note that our hyperplane  $H$  actually intersects  $n\binom{m}{n}$  edges of  $C$  at distinct points.

In the subsequent theorem we continue an examination of combinatorial properties of  $\text{co}(S, \mathcal{J}_S)$ . We show that in special cases the number of vertices of  $\text{co}(S, \mathcal{J}_S)$  cannot be too large. We need the following definition.

**Definition 4.3** A family of intervals  $\mathcal{J}_S = \{I_j = [a_j, b_j], j = 1, \dots, m\}$  is called *wide* if  $d_k + d_j > 1 - \alpha$  for all  $k \neq j$  where  $d_i = b_i - a_i$  and  $\alpha = \sum_{i=1}^m a_i$ .

One can easily check that the family  $\mathcal{J}_S$  considered in the example finishing the proof of Theorem 4.1 is wide only when  $n = 3$  or  $n = 4$  and in both cases the maximal number of vertices of  $\text{co}(S, \mathcal{J}_S)$  guaranteed by Theorem 4.1 is the same as the one guaranteed by the following theorem.

**Theorem 4.4** Let  $S = \{x_1, \dots, x_m\}$  be a set of distinct points in  $\mathbf{L}$ . Assume that  $\mathcal{J}_S = \{I_j = [a_j, b_j] : j = 1, \dots, m\}$  is a wide family of intervals, with  $a_j < b_j < 1 - \alpha + a_j$  and  $\alpha < 1$ . Then  $\text{co}(S, \mathcal{J}_S)$  is the convex hull of at most  $m(m - 1)$  points and this bound is best possible.

**Proof.** Similarly as in the proof of Theorem 4.1 we shall show that  $\text{co}(S, \mathcal{J}_S)$  is an image under a linear transformation of a polytope, denoted by  $W$ , having  $m(m - 1)$  vertices and lying in the hyperplane

$$\Pi_1 = \{(\xi_1, \dots, \xi_m) \in \mathbb{R}^m : \xi_1 + \xi_2 + \dots + \xi_m = 1\}.$$

To construct  $W$ , we first consider the points

$$v_j = (a_1, \dots, 1 - \alpha + a_j, \dots, a_m), \quad j = 1, \dots, m,$$

lying on  $\Pi_1$ . Clearly,  $\Delta = \text{conv}\{v_1, \dots, v_m\}$  is a fully dimensional simplex in  $\Pi_1$ . Define

$$W = \Delta \cap H_1^+ \cap H_2^+ \cap \dots \cap H_m^+$$

in which

$$H_j^+ = \{(\xi_1, \dots, \xi_m) \in \mathbb{R}^m : \xi_j \leq b_j\}, \quad j = 1, \dots, m,$$

is the halfspace bounded by the hyperplane

$$H_j = \{(\xi_1, \dots, \xi_m) \in \mathbb{R}^m : \xi_j = b_j\}.$$

There are  $m - 1$  edges of  $\Delta$  emanating from a vertex  $v_j$  of  $\Delta$ . Clearly, each one of these edges intersects the hyperplane  $H_j$  at a point  $v_j^k$ ,  $k \neq j$ . It is easy to check that

$$v_j^k = (a_1, \dots, b_j, \dots, c_k, \dots, a_m), \quad k \neq j,$$

where  $c_k = 1 - \alpha - d_j + a_k$ . Thus, each intersection  $\Delta_j = \Delta \cap H_j$ ,  $j = 1, \dots, m$ , is a simplex with  $m - 1$  vertices

$$v_j^1, v_j^2, \dots, v_j^{j-1}, v_j^{j+1}, \dots, v_j^m.$$

Now we shall check that every vertex of any simplex  $\Delta_j$ ,  $j = 1, \dots, m$ , is a vertex of  $W$ . Indeed, take  $v_j^k = (a_1, \dots, b_j, \dots, c_k, \dots, a_m)$ ,  $k \neq j$ . Obviously  $v_j^k \in \Delta \cap H_t^+$  for  $t \neq k$ . To show that also  $v_j^k \in \Delta \cap H_k^+$  we need to check that  $c_k$  (the  $k$ -th coordinate of  $v_j^k$ ) is less than  $b_k$ . This is true since the inequality

$$c_k = 1 - \alpha - d_j + a_k < b_k$$

is equivalent to

$$1 - \alpha < b_k - a_k + d_j = d_k + d_j$$

and the latter inequality is true because the family  $\mathcal{J}_S$  is wide. In this way we have shown that every vertex of  $\Delta$  gives rise to  $m - 1$  vertices of  $W$ . Thus  $W$  is a polytope with  $m(m - 1)$  vertices.

Now consider a linear transformation  $T_S : \mathbb{R}^m \rightarrow \mathbf{L}$  defined in (1.3). We want to show that  $\text{co}(S, \mathcal{J}_S) = T_S(W)$ . The inclusion  $T_S(W) \subseteq \text{co}(S, \mathcal{J}_S)$  simply follows from the definitions given above.

To show the reverse inclusion, suppose to the contrary that there exists

$$z \in \text{co}(S, \mathcal{J}_S) \setminus T_S(W).$$

Of course,  $z = \sum_{j=1}^m \mu_j x_j$  for some  $\mu_1, \dots, \mu_m$  such that  $a_j \leq \mu_j \leq b_j$ ,  $j = 1, \dots, m$ , and  $\sum_{j=1}^m \mu_j = 1$ . Obviously,

$$(\mu_1, \dots, \mu_m) \in \Pi_1 \cap \bigcap_{j=1}^m H_j^+ \setminus W.$$

From the definition of  $W$  it follows now that  $(\mu_1, \dots, \mu_m) \notin \Delta$ . As  $\Delta$  is a fully dimensional simplex in  $\Pi_1$  we have

$$(\mu_1, \dots, \mu_m) \in \text{aff}\{v_1, \dots, v_m\} \setminus \text{conv}\{v_1, \dots, v_m\}. \quad (4.1)$$

From (4.1) we get

$$(\mu_1, \dots, \mu_m) = \sum_{j=1}^m \lambda_j v_j \quad (4.2)$$

for some numbers  $\lambda_1, \dots, \lambda_m$ , satisfying  $\sum_{j=1}^m \lambda_j = 1$ , among which at least one does not belong to the interval  $[0, 1]$ . In connection with the last observation we infer that there exists  $i_0$  such that  $\lambda_{i_0} < 0$ . It is easy to check that (4.2) is equivalent to

$$(\mu_1, \dots, \mu_m) = (a_1 + \lambda_1(1 - \alpha), \dots, a_m + \lambda_m(1 - \alpha)),$$

which gives  $\mu_{i_0} = a_{i_0} + \lambda_{i_0}(1 - \alpha) < a_{i_0}$  and contradicts the condition  $a_{i_0} \leq \mu_{i_0} \leq b_{i_0}$ . Thus  $\text{co}(S, \mathcal{J}_S) \subseteq T_S(W)$  and consequently  $\text{co}(S, \mathcal{J}_S) = T_S(W)$ . Therefore  $\text{co}(S, \mathcal{J}_S)$  cannot have more than  $m(m - 1)$  vertices.

Next we show that the number  $m(m - 1)$  is attained for wide families. Let  $e_1, \dots, e_m$  be the unit vectors in  $\mathbb{R}^m$ . Define

$$S = \{e_1, \dots, e_m\}, \quad \mathcal{J}_S = \{I_1, \dots, I_m\},$$

$$\text{where } I_j = \left[0, \frac{2}{3}\right], \quad j = 1, \dots, m.$$

Clearly  $\mathcal{J}_S$  is a wide family and  $\text{co}(S, \mathcal{J}_S)$  has exactly  $m(m - 1)$  vertices.  $\square$

## 5 Minimal families of intervals

The convex interval hull of a set  $S$  essentially depends on the family of intervals  $\mathcal{J}_S$  associated with  $S$ . In Example 2.1 we saw that the convex interval hull produced by the family  $\mathcal{J}_S$  of intervals  $[0, t_j]$  with  $t_j > 1$  produces the same convex interval hull as the family of intervals  $[0, 1]$ . This observation indicates that the latter family is in some sense minimal. In this section we define and explore the minimality of families of intervals.

**Definition 5.1** Let  $S$  be a finite set of points in  $\mathbf{L}$ . A family of intervals  $\mathcal{J}_S = \{I_1, \dots, I_m\}$  is a *minimal interval family for the set  $S$*  if

$$\mathcal{J}'_S = \{I'_1, \dots, I'_m\}, \quad I'_j \subseteq I_j, \quad j = 1, \dots, m, \quad \text{and} \quad \text{co}(S, \mathcal{J}'_S) = \text{co}(S, \mathcal{J}_S)$$

imply that

$$I'_j = I_j, \quad j = 1, \dots, m.$$

**Definition 5.2** Let  $\mathcal{J} = \{I_1, \dots, I_m\}$  be a family of bounded intervals such that  $I_j = [a_j, b_j]$ ,  $a_j \leq b_j$ ,  $j = 1, \dots, m$ . Set  $\alpha = \sum_{j=1}^m a_j$  and  $\beta = \sum_{j=1}^m b_j$ . The family  $\mathcal{J}$  is called *irreducible* if  $b_k - a_k \leq \min\{1 - \alpha, \beta - 1\}$  for all  $k = 1, \dots, m$ .

Let, as before,

$$\mathcal{J} = \{I_1, \dots, I_m\}, \quad I_j = [a_j, b_j], \quad j = 1, \dots, m, \quad \alpha = \sum_{j=1}^m a_j, \quad \beta = \sum_{j=1}^m b_j,$$

and assume  $\alpha \leq 1 \leq \beta$ . In the rest of this section we will use the following notation. With the family  $\mathcal{J}$  we associate the following family  $\widehat{\mathcal{J}}$ :

$$\widehat{\mathcal{J}} = \{\widehat{I}_1, \dots, \widehat{I}_m\}, \quad \widehat{I}_j = [\widehat{a}_j, \widehat{b}_j], \quad j = 1, \dots, m, \quad \widehat{\alpha} = \sum_{j=1}^m \widehat{a}_j, \quad \widehat{\beta} = \sum_{j=1}^m \widehat{b}_j,$$



where

$$\widehat{a}_j = \max\{a_j, b_j - (\beta - 1)\}, \quad \widehat{b}_j = \min\{b_j, a_j + (1 - \alpha)\}.$$

Since we assume  $\alpha \leq 1 \leq \beta$ , we clearly have

$$a_j \leq \widehat{a}_j \leq \widehat{b}_j \leq b_j, \quad j = 1, \dots, m. \quad (5.1)$$

The following implication is straightforward: if  $\mathcal{J}$  is irreducible, then  $\mathcal{J} = \widehat{\mathcal{J}}$ . In the next lemma we study the relationship between  $\mathcal{J}$  and  $\widehat{\mathcal{J}}$  further. Among other statements we prove the converse of the last implication. We set

$$\Pi_1 = \left\{ (\zeta_1, \dots, \zeta_m) \in \mathbb{R}^m : \zeta_1 + \dots + \zeta_m = 1 \right\}.$$

**Lemma 5.3** *Let  $\mathcal{J} = \{I_1, \dots, I_m\}$ ,  $I_j = [a_j, b_j]$ ,  $j = 1, \dots, m$ , be a family of bounded intervals. Set  $\alpha = \sum_{j=1}^m a_j$  and  $\beta = \sum_{j=1}^m b_j$  and assume  $\alpha \leq 1 \leq \beta$ . The following three statements hold.*

(a) *Let  $k \in \{1, \dots, m\}$ . The projection of the set*

$$(I_1 \times \dots \times I_m) \cap \Pi_1 \subset \mathbb{R}^m$$

*to the  $k$ -th coordinate axes in  $\mathbb{R}^m$  is the interval  $\widehat{I}_k = [\widehat{a}_k, \widehat{b}_k]$ .*

(b)  $(\widehat{I}_1 \times \dots \times \widehat{I}_m) \cap \Pi_1 = (I_1 \times \dots \times I_m) \cap \Pi_1$ .

(c) *The family  $\widehat{\mathcal{J}}$  is irreducible.*

**Proof.** The statement (a) claims the equality of two sets. To prove it, let

$$(\xi_1, \dots, \xi_m) \in (I_1 \times \dots \times I_m) \cap \Pi_1.$$

Then

$$\xi_k = 1 - \sum_{j=1, j \neq k}^m \xi_j \leq 1 - \sum_{j=1, j \neq k}^m a_j = 1 - (\alpha - a_k)$$

and

$$\xi_k = 1 - \sum_{j=1, j \neq k}^m \xi_j \geq 1 - \sum_{j=1, j \neq k}^m b_j = 1 - (\beta - b_k).$$

Since  $a_k \leq \xi_k \leq b_k$ , it follows that  $\widehat{a}_k \leq \xi_k \leq \widehat{b}_k$ . This proves that the projection onto  $k$ -th coordinate is contained in the interval  $\widehat{I}_k$ .

For simplicity of notation, we will prove the converse inclusion for  $k = 1$ . Let  $\xi_1 \in \widehat{I}_1$ . Then

$$1 - \min\{b_1, a_1 + 1 - \alpha\} \leq 1 - \xi_1 \leq 1 - \max\{a_1, b_1 - \beta + 1\}$$

and consequently

$$\alpha - a_1 \leq 1 - \xi_1 \leq \beta - b_1. \quad (5.2)$$

Since the function

$$(\zeta_2, \dots, \zeta_m) \mapsto \sum_{j=2}^m \zeta_j$$

is a continuous function on  $I_2 \times \dots \times I_m$  with the minimum  $\alpha - a_1$  and the maximum  $\beta - b_1$ , its range is  $[\alpha - a_1, \beta - b_1]$ . Now (5.2) implies that there exists

$$(\xi_2, \dots, \xi_m) \in I_2 \times \dots \times I_m$$

such that  $\sum_{j=2}^m \xi_j = 1 - \xi_1$ . Thus

$$(\xi_1, \dots, \xi_m) \in (I_1 \times \dots \times I_m) \cap \Pi_1,$$

and (a) is proved.

The statement (b) follows from the fact that (a) holds for all  $k = 1, \dots, m$ , and  $\widehat{I}_k \subseteq I_k$ .

To prove (c), we notice that (b) implies that for each  $k = 1, \dots, m$ , the projection of  $(\widehat{I}_1 \times \dots \times \widehat{I}_m) \cap \Pi_1$  to the  $k$ -th coordinate axes in  $\mathbb{R}^m$  is the interval  $\widehat{I}_k = [\widehat{a}_k, \widehat{b}_k]$ . Furthermore, an application of (a) to the family  $\widehat{\mathcal{J}}$  yields that the same projection is the interval

$$\left[ \max\{\widehat{a}_k, \widehat{b}_k - (\widehat{\beta} - 1)\}, \min\{\widehat{b}_k, \widehat{a}_k + (1 - \widehat{\alpha})\} \right].$$

Consequently,

$$\widehat{a}_k = \max\{\widehat{a}_k, \widehat{b}_k - (\widehat{\beta} - 1)\}, \quad \widehat{b}_k = \min\{\widehat{b}_k, \widehat{a}_k + (1 - \widehat{\alpha})\},$$

and hence

$$\widehat{a}_k \geq \widehat{b}_k - (\widehat{\beta} - 1), \quad \widehat{b}_k \leq \widehat{a}_k + (1 - \widehat{\alpha}).$$

This implies that  $\widehat{\mathcal{J}}$  is irreducible and the lemma is proved.  $\square$

**Proposition 5.4** *Let  $S$  be a finite subset of  $\mathbf{L}$  and let  $\mathcal{J}_S$  be a corresponding family of bounded intervals such that  $\text{co}(S, \mathcal{J}_S) \neq \emptyset$ . Then*

$$\text{co}(S, \widehat{\mathcal{J}}_S) = \text{co}(S, \mathcal{J}_S).$$

**Proof.** The proposition follows from (b) in Lemma 5.3.  $\square$

**Theorem 5.5** *Let  $S$  be a finite subset of  $\mathbf{L}$  and let  $\mathcal{J}_S$  be a corresponding family of bounded intervals such that  $\text{co}(S, \mathcal{J}_S) \neq \emptyset$ . If  $\mathcal{J}_S$  is a minimal family for  $S$ , then  $\mathcal{J}_S$  is irreducible.*

**Proof.** We prove the contrapositive. Assume that  $S$  has  $m$  elements and let  $\mathcal{J}_S = \{I_1, \dots, I_m\}$ . Assume further that  $\mathcal{J}_S$  is not irreducible. Then there exists  $k \in \{1, \dots, m\}$  such that  $\widehat{I}_k$  is a proper subset of  $I_k$ . But  $\text{co}(S, \widehat{\mathcal{J}}_S) = \text{co}(S, \mathcal{J}_S)$  by Proposition 5.4. Since  $\widehat{I}_j \subseteq I_j$  for all  $j = 1, \dots, m$ ,  $\mathcal{J}_S$  is not a minimal family for  $S$ .  $\square$

The following example shows that the converse of Theorem 5.5 is not true.

**Example 5.6** Consider the set  $S$  of 4 points in  $\mathbb{R}^2$  from Example 2.7. Let  $\mathcal{J}_S$  be the family of four copies of the interval  $[0, 1]$ . Then  $\text{co}(S, \mathcal{J}_S) = \text{conv } S$ . The family  $\mathcal{J}_S$  is clearly irreducible, but it is not a minimal family for  $S$ , since the family  $\mathcal{J}'_S = \{[0, 1], [0, 1], [0, 1], [0, t]\}$ , for arbitrary  $t \in [0, 1)$ , clearly produces the same convex interval hull.

In the next theorem we show that for affinely independent sets the converse of Theorem 5.5 holds true. Recall that a set  $S = \{y_1, \dots, y_m\}$  of points in  $\mathbf{L}$  is *affinely independent* if and only if the affine mapping

$$(\xi_1, \dots, \xi_m) \mapsto \xi_1 y_1 + \dots + \xi_m y_m \quad (5.3)$$

is a bijection between  $\Pi_1^m$  and  $\text{aff } S$ .

**Theorem 5.7** *Let  $S$  be a finite affinely independent subset of  $\mathbf{L}$  and let  $\mathcal{J}_S$  be an associated family of bounded intervals. The family  $\mathcal{J}_S$  is a minimal family for  $S$  if and only if it is irreducible.*

**Proof.** Let  $S$  be an affinely independent set with  $m$  elements and let  $\mathcal{J}_S = \{I_1, \dots, I_m\}$ . We prove the contrapositive of the “if” part of the theorem. Assume that  $\mathcal{J}_S$  is not a minimal family for  $S$ . Then there exist a family of intervals

$$\begin{aligned} \mathcal{J}'_S = \{I'_1, \dots, I'_m\} \quad \text{such that} \quad I'_j \subseteq I_j, \quad j = 1, \dots, m, \\ \text{co}(S, \mathcal{J}'_S) = \text{co}(S, \mathcal{J}_S), \end{aligned} \quad (5.4)$$

and there exists  $k \in \{1, \dots, m\}$  for which  $I'_k$  is a proper subset of  $I_k$ . Setting  $I'_k = [a'_k, b'_k]$ ,  $I_k = [a_k, b_k]$ , the last condition is equivalent to

$$b'_k - a'_k < b_k - a_k. \quad (5.5)$$

Since the mapping (5.3) is a bijection, (5.4) is equivalent to

$$(I'_1 \times \dots \times I'_m) \cap \Pi_1 = (I_1 \times \dots \times I_m) \cap \Pi_1.$$

By Lemma 5.3(a), the last equality implies that  $\widehat{\mathcal{J}}'_S = \widehat{\mathcal{J}}_S$ . Therefore, by (5.1) and (5.5),

$$\widehat{b}_k - \widehat{a}_k = \widehat{b}'_k - \widehat{a}'_k \leq b'_k - a'_k < b_k - a_k.$$

Hence  $\widehat{\mathcal{J}}_S \neq \mathcal{J}_S$ , and consequently  $\mathcal{J}_S$  is not irreducible.  $\square$

## 6 The convex interval hull and the homothety

Let  $\delta$  be a nonzero real number and  $v \in \mathbf{L}$ . The transformation  $H_v^\delta : \mathbf{L} \rightarrow \mathbf{L}$  defined by

$$H_v^\delta(x) := v + \delta x, \quad x \in \mathbf{L},$$

is called a *homothety*. If  $\delta > 0$  the homothety is called *positive* and if  $\delta < 0$  the homothety is called *negative*. The number  $\delta$  is called the *ratio of the homothety*. The image of  $K \subset \mathbf{L}$  under  $H_v^\delta$  is denoted by  $H_v^\delta(K)$  and it is called a *homothet of  $K$* . It is convenient to set  $H_v^0(K) = \emptyset$ .

Let  $S = \{x_1, \dots, x_m\}$ , be a finite set of points in  $\mathbf{L}$ . We are interested only in homotheties that map  $\text{aff } S$  to  $\text{aff } S$ . Let  $v \in \mathbf{L}$  and  $\delta \neq 0$ . Clearly  $H_v^\delta(\text{aff } S) \subseteq \text{aff } S$  if and only if there exist  $\nu_j \in \mathbb{R}$ ,  $j = 1, \dots, m$ , such that

$$v = \sum_{j=1}^m \nu_j x_j \quad \text{and} \quad \delta = 1 - \sum_{j=1}^m \nu_j. \quad (6.1)$$

**Theorem 6.1** *Let  $S = \{x_1, \dots, x_m\}$  be a finite set of points in  $\mathbf{L}$  and let  $\mathcal{J}_S = \{I_1, \dots, I_m\}$  be a corresponding family of nonempty intervals. Let  $v \in \mathbf{L}$  and  $\delta \neq 0$  be such that  $H_v^\delta(\text{aff } S) \subseteq \text{aff } S$ . Assume that (6.1) holds and set  $h_j(t) = \nu_j + \delta t$ ,  $t \in \mathbb{R}$ . Then*

$$H_v^\delta(\text{co}(S, \mathcal{J}_S)) = \text{co}(S, \mathcal{J}'_S),$$

where

$$\mathcal{J}'_S = \{I'_1, \dots, I'_m\}, \quad I'_j = h_j(I_j), \quad j = 1, \dots, m.$$

**Proof.** To prove the inclusion  $\text{co}(S, \mathcal{J}'_S) \subseteq H_v^\delta(\text{co}(S, \mathcal{J}_S))$ , let  $y \in \text{co}(S, \mathcal{J}'_S)$ . Then there exist  $\xi_j \in I_j$ ,  $j = 1, \dots, m$ , such that

$$y = \sum_{j=1}^m h_j(\xi_j) x_j \quad \text{and} \quad \sum_{j=1}^m h_j(\xi_j) = 1.$$

Since, by (6.1),

$$\sum_{j=1}^m \xi_j = \frac{1}{\delta} \left( 1 - \sum_{j=1}^m \nu_j \right) = 1,$$

with  $x = \sum_{j=1}^m \xi_j x_j \in \text{co}(S, \mathcal{J}_S)$  we have

$$y = \sum_{j=1}^m (\nu_j + \delta \xi_j) x_j = \sum_{j=1}^m \nu_j x_j + \delta \sum_{j=1}^m \xi_j x_j = H_v^\delta(x).$$

The converse inclusion is proved similarly and the theorem is established.  $\square$

**Corollary 6.2** *Let  $S = \{x_1, \dots, x_m\}$  be a finite set of points in  $\mathbf{L}$  and let  $c_j \in \mathbb{R}$  be such that  $\gamma = \sum_{j=1}^m c_j \neq 1$ . Set  $h_j(t) = c_j + (1 - \gamma)t$  and*

$$\mathcal{J}'_S = \{I'_1, \dots, I'_m\} \quad \text{with} \quad I'_j = h_j([0, 1]), \quad j = 1, \dots, m.$$

Then

$$\text{co}(S, \mathcal{J}'_S) = H_v^{1-\gamma}(\text{conv } S), \quad \text{where} \quad v = \sum_{j=1}^m c_j x_j.$$

**Remark 6.3** We continue to use the notation of Corollary 6.2. Further, we assume that  $c_j \geq 0, j = 1, \dots, m$ , and  $0 < \gamma < 1$ . Simple algebra yields

$$H_v^{1-\gamma}(x) = v + (1 - \gamma)x = \frac{1}{\gamma}v + (1 - \gamma)\left(x - \frac{1}{\gamma}v\right), \quad x \in \text{aff } S.$$

This expression shows that  $\frac{1}{\gamma}v$  is a fixed point of  $H_v^{1-\gamma}$ . Since  $0 < 1 - \gamma < 1$  and  $\frac{1}{\gamma}v \in \text{conv } S$ , the homotet  $H_v^{1-\gamma}(\text{conv } S)$  is a contraction of  $\text{conv } S$  and it is completely contained in  $\text{conv } S$ .

The Gauss-Lucas theorem, see [7], states that all the roots of the derivative of a complex non-constant polynomial  $p$  lie in the convex hull of the roots of  $p$ , called the Lucas polygon of  $p$ . The reasoning presented in Remark 6.3 was used in [3] to improve the Gauss-Lucas theorem by proving that all the nontrivial roots of the derivative of  $p$  lie in a convex polygon that is a strict contraction of the Lucas polygon of  $p$  and that is completely contained in it.

We conclude this article with a result motivated by Examples 2.2, 2.3, 2.8 and 2.9. It is clear that the convex interval hull  $\text{co}(S, \mathcal{J}_S)$  in Figure 2 is the closure of a set difference of  $\text{conv } S$  and the union of two smaller homotets of  $\text{conv } S$ . Similarly,  $\text{co}(S, \mathcal{J}_S)$  in Figure 1 is the closure of a set difference of a large homotet of  $\text{conv } S$  and the union of two smaller homotets of  $\text{conv } S$ . The reader will easily observe analogous properties of the convex interval hulls in Figures 3, 13 and 14. In Theorem 6.5 below we give a general result which explains these observations.

**Lemma 6.4** *Let  $\mathcal{J} = \{I_1, \dots, I_m\}$ ,  $I_j = [a_j, b_j], j = 1, \dots, m$ , be an irreducible family of intervals. Set  $\alpha = \sum_{j=1}^m a_j$  and  $\beta = \sum_{j=1}^m b_j$  and assume*

$\alpha \leq 1 \leq \beta$ . For  $k, j \in \{1, \dots, m\}$  define

$$I_j^0 = [a_j, a_j + (1 - \alpha)],$$

$$I_j^k = \begin{cases} [a_j, a_j + (1 - \alpha) - (b_k - a_k)] & \text{for } j \neq k, \\ [b_j, a_j + (1 - \alpha)] & \text{for } j = k. \end{cases}$$

Set

$$B = (I_1 \times \dots \times I_m) \cap \Pi_1, \quad B_u = \Pi_1 \cap \bigcup_{k=1}^m (I_1^k \times \dots \times I_m^k).$$

Then  $B \cap B_u = \emptyset$  and

$$B \cup B_u = (I_1^0 \times \dots \times I_m^0) \cap \Pi_1. \quad (6.2)$$

**Proof.** The equality  $B \cap B_u = \emptyset$  is obvious. Since  $\mathcal{J}$  is irreducible we have  $b_j \leq a_j + 1 - \alpha$  for all  $j = 1, \dots, m$ . Consequently  $B \cup B_u$  is a subset of  $(I_1^0 \times \dots \times I_m^0) \cap \Pi_1$ .

To prove the converse inclusion in (6.2), let

$$(\xi_1, \dots, \xi_m) \in (I_1^0 \times \dots \times I_m^0) \cap \Pi_1 \quad (6.3)$$

and assume that

$$(\xi_1, \dots, \xi_m) \notin (I_1 \times \dots \times I_m) \cap \Pi_1. \quad (6.4)$$

Then there exists  $k \in \{1, \dots, m\}$  such that

$$\xi_k \in [b_k, a_k + (1 - \alpha)]. \quad (6.5)$$

Next we prove the implication

$$\sum_{j=1}^m \xi_j = 1 \Rightarrow \xi_j \leq a_j + (1 - \alpha) - (b_k - a_k) \quad (\forall j \in \{1, \dots, m\} \setminus \{k\}). \quad (6.6)$$

Since the contrapositive is easier to prove, assume

$$\exists l \in \{1, \dots, m\} \setminus \{k\} \quad \text{such that} \quad \xi_l > a_l + (1 - \alpha) - (b_k - a_k). \quad (6.7)$$

Then, using (6.5) and (6.7), we find

$$\sum_{j=1}^m \xi_j > b_k + (a_l + (1 - \alpha) - (b_k - a_k)) + (\alpha - a_k - a_l) = 1,$$

and (6.6) is proved. Hence, we have shown that (6.3), (6.4) and (6.5) imply that

$$\xi_j \in [a_j, a_j + \leq (1 - \alpha) - (b_k - a_k)] \quad (\forall j \in \{1, \dots, m\} \setminus \{k\}).$$

This together with (6.5) implies that  $(\xi_1, \dots, \xi_m) \in B_u$  and the lemma is proved.  $\square$

**Theorem 6.5** *Let  $S = \{x_1, \dots, x_m\}$  be an affinely independent set in  $\mathbf{L}$ . Let  $\mathcal{J}_S = \{I_1, \dots, I_m\}$ ,  $I_j = [a_j, b_j]$ ,  $j = 1, \dots, m$ , be an irreducible family of intervals and assume  $\alpha = \sum_{j=1}^m a_j < 1$ . Then  $\text{co}(S, \mathcal{J}_S)$  is the closure of the set difference of the sets*

$$H_v^\delta(\text{conv } S) \quad \text{and} \quad \bigcup_{j=1}^m H_{v+d_j x_j}^{\delta-d_j}(\text{conv } S)$$

where  $v = \sum_{j=1}^m a_j x_j$ ,  $\delta = 1 - \alpha$ , and  $d_j = b_j - a_j$ ,  $j = 1, \dots, m$ .

**Proof.** The claim of the theorem is equivalent to the equality

$$\text{co}(S, \mathcal{J}_S) \cup \bigcup_{j=1}^m H_{v+d_j x_j}^{\delta-d_j}(\text{conv } S) = H_v^\delta(\text{conv } S) \quad (6.8)$$

together with the condition that the set  $\text{co}(S, \mathcal{J}_S)$  has no common interior points with the polytopes  $H_{v+d_j x_j}^{\delta-d_j}(\text{conv } S)$ ,  $j = 1, \dots, m$ . To prove (6.8) and the stated condition we use Lemma 6.4 and the notation introduced there. For  $k = 1, \dots, m$ , set

$$\mathcal{J}_S^0 = \{I_1^0, \dots, I_m^0\}, \quad \mathcal{J}_S^k = \{I_1^k, \dots, I_m^k\}, \quad \overline{\mathcal{J}}_S^k = \{\overline{I}_1^k, \dots, \overline{I}_m^k\}.$$

Since  $S$  is affinely independent the affine mapping

$$(\xi_1, \dots, \xi_m) \mapsto \xi_1 y_1 + \dots + \xi_m y_m \quad (6.9)$$

is a bijection between  $\Pi_1$  and  $\text{aff } S$ . Together with Lemma 6.4 this implies

$$\text{co}(S, \mathcal{J}_S) \cup \bigcup_{k=1}^m \text{co}(S, \mathcal{J}_S^k) = \text{co}(S, \mathcal{J}_S^0) \quad (6.10)$$

and, for  $k = 1, \dots, m$ ,

$$\text{co}(S, \mathcal{J}_S) \cap \text{co}(S, \mathcal{J}_S^k) = \emptyset.$$

Since (6.9) defines a continuous mapping it follows that  $\text{co}(S, \overline{\mathcal{J}}_S^k)$  is a closure of  $\text{co}(S, \mathcal{J}_S^k)$ . Therefore, for  $k = 1, \dots, m$ , the polytopes  $\text{co}(S, \overline{\mathcal{J}}_S^k)$  and  $\text{co}(S, \mathcal{J}_S)$  have no common interior points.

By Corollary 6.2 we have

$$\text{co}(S, \overline{\mathcal{J}}_S^k) = H_{v+d_k x_k}^{\delta-d_k}(\text{conv } S) \quad \text{and} \quad \text{co}(S, \mathcal{J}_S^0) = H_v^\delta(\text{conv } S).$$

Substituting the last equalities into (6.10) we get (6.8). The proof is complete.  $\square$

## References

- [1] R. Ahlswede and Z. Zhang, *An identity in combinatorial extremal theory*, Adv. Math. **80** (1990), 137–151.
- [2] V. Boltyanski, H. Martini and P. S. Soltan, *Excursions into Combinatorial Geometry*, Springer, 1997.
- [3] B. Ćurgus and V. Mascioni, *A contraction of the Lucas polygon*, Proc. Amer. Math. Soc. **132** (2004) 2973-2981.
- [4] J. W. Green and W. Gustin, *Quasiconvex sets*, Canad. J. Math. **2** (1950), 489-507.
- [5] T. S. Motzkin, *Endovectors*, Proceedings of the Seventh Symposium in Pure Mathematics of the American Mathematical Society: *Convexity*, 1963, pp. 361-387.
- [6] M. L. J. van de Vel, *Theory of convex structures*, North-Holland, 1993.
- [7] R. Webster, *Convexity*, Oxford University Press, 1994.